

SC80 / SC100 / SC120

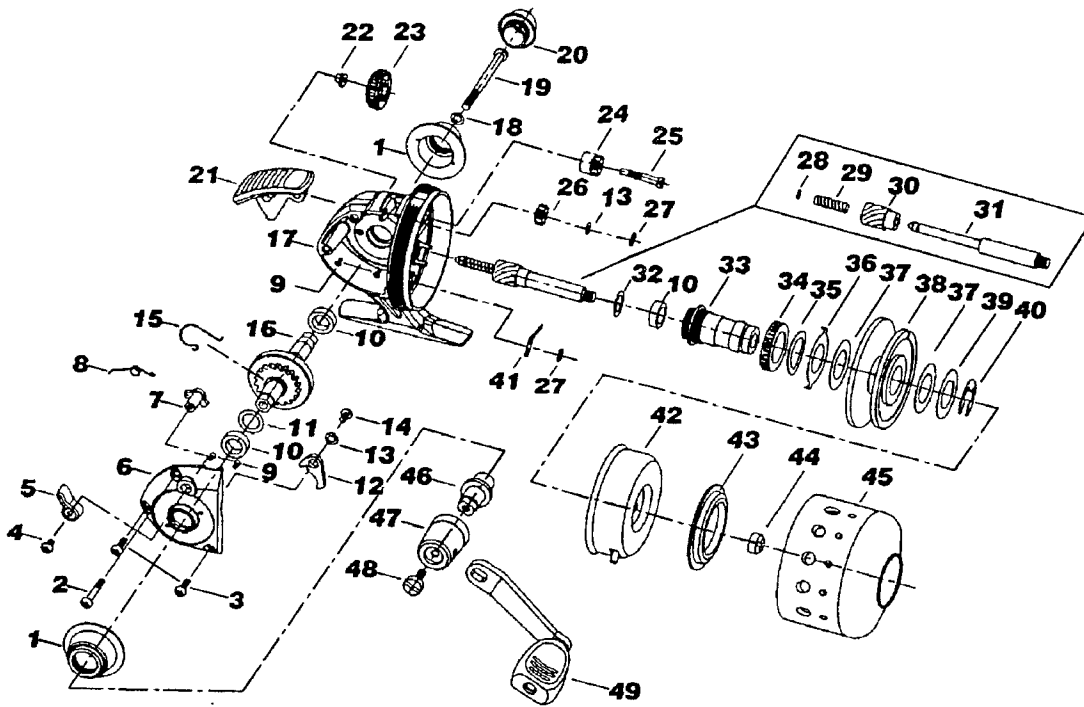

Key No.	Parts No.	Parts Name
1	W31-5001	SIDE RING
2	W31-5101	SIDE COVER SCREW A
3	W31-5201	SIDE COVER SCREW B
4	W31-5301	SIDE COVER SCREW C
5	W31-5401	A/R LEVER
6	W31-5501	SIDE COVER
7	W31-5701	A/R CAM
8	W31-5801	A/R CAM SPRING
9	W31-5901	SIDE RING SCREW
10	W31-6001	BUSHING
11	W31-6101	DRIVE GEAR WASHER
12	W31-6201	A/R PAWL
13	W31-6301	WASHER
14	W31-6401	A/R PAWL SCREW
15	W31-6501	A/R PAWL SPRING
16	W31-6601	DRIVE GEAR
17	W31-6701	BODY
18	W31-7001	HANDLE WASHER
19	W31-7101	HANDLE SCREW B
20	W31-7201	HANDLE SCREW CAP
21	W31-7301	PUSH BUTTON
22	W31-7401	DRAG DIAL COLLAR
23	W31-7501	DRAG DIAL
24	W31-7601	DRIVE GEAR A
25	W31-7701	DRIVE GEAR SCREW
26	W31-7801	DRIVE GEAR B
27	W31-7901	RET
28	W31-8001	SPRING RET
29	W31-8101	MAIN SHAFT SPRING
30	W31-8201	PINION GEAR
31	W31-8301	MAIN SHAFT
32	W31-8501	MAIN SHAFT WASHER
33	W31-8601	SPOOL METAL
34	W31-8801	DRAG PLT
35	W31-8901	DRAG SPRING WASHER

Key No.	Parts No.	Parts Name
36	W31-9001	EARED WASHER
37	W31-9101	DRAG WASHER
38	W31-9201	SPOOL
39	W31-9501	KEY WASHER
40	W31-9601	SPOOL RET
41	W31-9701	CLICK SPRING
42	W31-9801	ROTOR
43	W32-0101	LINE STOPPER
44	W32-0301	ROTOR NUT
45	W32-0401	FRONT COVER
46	W32-0701	HANDLE METAL
47	W32-0801	HANDLE STAND
48	W32-0901	HANDLE SCREW A
49	W32-1001	HANDLE

SC100 Special Parts

Key No.	Parts No.	Parts Name
6	W31-5601	SIDE COVER
17	W31-6801	BODY
38	W31-9301	SPOOL
42	W31-9901	ROTOR
43	W32-0201	LINE STOPPER
45	W32-0501	FRONT COVER

SC120 Special Parts

Key No.	Parts No.	Parts Name
6	W31-5601	SIDE COVER
17	W31-6901	BODY
31	W31-8401	MAIN SHAFT
33	W31-8701	SPOOL METAL
38	W31-9401	SPOOL
42	W32-0001	ROTOR
43	W32-0201	LINE STOPPER
45	W32-0601	FRONT COVER