

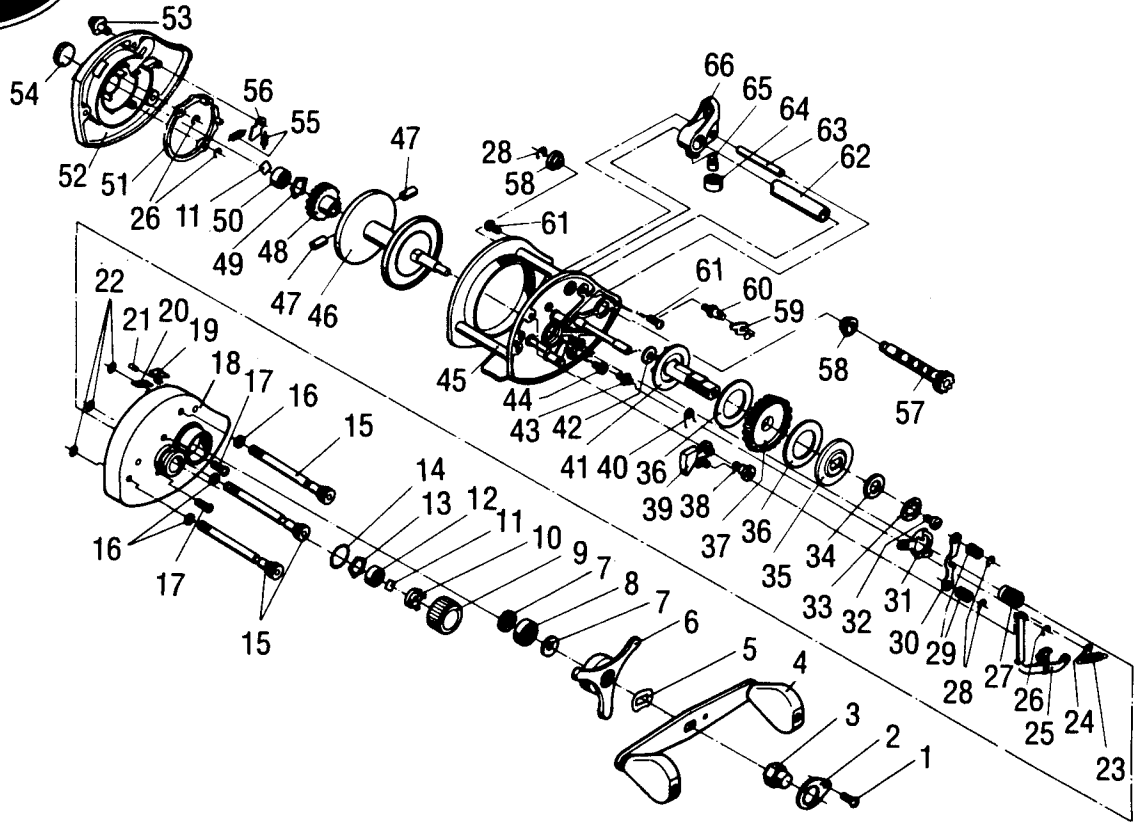

BB2C



Key No.	Part No.	Description	Price	Key No.	Part No.	Description	Price
1	P306000	Handle Locking Plate Screw	.30	35	P306097	Drag Pressure Plate	1.7
2	P306002	Handle Locking Plate	2.65	36	P306102	Fiber Drag Washer	1.7
3	P306005	Handle Retaining Nut	1.40	37	P306106	Main Gear	8.3
4	P306008	Handle	6.45	38	P306112	Spool Release Button Screw	1.0
5	P306013	Tri Star Drag Tension Plate	.30	39	P306114	Spool Release Button	2.8
6	P306015	Tri Star Drag Control	6.45	40	P306119	Spool Release Button Spring	.4
7	P306021	Shouldered Handle Bearing Spacer	.30	41	P306126	Ratchet Gear Assembly	12.7
8	P306025	Handle Ball Bearing	11.25	42	P306129	Drive Shaft Assembly Washer	.3
9	P306026	Cast Control Cap	2.20	43	P306130	Kick Lever Screw	1.7
10	P306030	Cast Control Tension Assembly	1.30	44	P306131	Stopper Pin	.3
11	P306035	Friction Shim	.30	45	P306135	Main Body Assembly	69.7
12	P306036	Spool Ball Bearing	12.00	46	P306150	U Spool Standard	33.0
13	P306038	Bearing Retaining Spring	.30	47	P306152	Brake Block	.3
14	P306039	Cast Control O-Ring	.55	48	P306160	Click Wheel	.3
15	P306042	Side Plate Finger Screws	6.80	49	P306161	Retaining Ring	.3
16	P306046	Washer	.30	50	P306162	Left Side Plate Ball Bearing	11.9
17	P306047	Side Plate Retaining Screw	.30	51	P306163	Click Spring Retaining Ring	.3
18	P306053	Right Side Plate	20.55	52	P306166	Left Side Plate	10.9
19	P306063	Anti Reverse Button	.55	53	P306173	Click Button	1.7
20	P306064	Anti Reverse Spring	.30	54	P306209	Emblem	2.3
21	P306065	Anti Reverse Pin	.55	55	P306174	Click Spring	.3
22	P306068	O-Ring	.30	56	P306175	Click Claw	.3
23	P306069	Slider Spring	.30	57	P306177	Level Wind Gear	7.7
24	P306070	Retaining Ring	.30	58	P306181	Oilless Bushing	.3
25	P306071	Slider Assembly	3.20	59	P306185	Anti Reverse Claw	1.8
26	P306073	Slider Assembly Retaining Clip	.30	60	P306188	Anti Reverse Claw Screw	.8
27	P306076	Pinion Gear	5.80	61	P306190	Stabilizer Bar Screw	.3
28	P306079	Retaining Clip	.30	62	P306193	Level Wind Gear Guard	3.0
29	P306080	Clutch Spring	.30	63	P306197	Level Wind Stabilizer Bar	2.0
30	P306083	Clutch Lever	.85	64	P306200	Line Guide Block Cap	1.3
31	P306085	Clutch Cam	1.10	65	P306202	Pawl (Steel)	3.4
32	P306089	Drive Shaft Retaining Screw	.55	65	P306203	Pawl (Zirconia)	6.8
33	P306092	Drag Spring Washer	.55	66	P306204	Line Guide Block	4.8
34	P306094	Drag Pressure Plate Washer	.30				

Prices subject to change without notice. Prices do not include postage and handling.

PLEASE ORDER BY PART NUMBER

Rev. 6/95

Zebco Division Brunswick Corporation, Box 270, Tulsa, OK 74101 USA 918-836-5581

